

# AUTOQUIP 3077/3092/3099

## ERGONOMIC 55 GALLON ELEVATOR SYSTEM

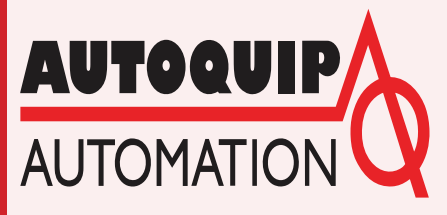

- 3077-5520-001 - 55 Gallon Direct Drive Agitator with Drum Lid only
- \*3092-BG55-000 - 55 Gallon Back Geared Agitator with Elevator and Drum Lid
- \*3092-BG55-001 - 55 Gallon Back Geared Agitator with Drum Lid only
- 3099-5520-000 - 55 Gallon Direct Drive Agitator with Elevator and Drum Lid
- 3099-5520-001 - 55 Gallon Direct Drive Agitator with Elevator
- 3099-5520-002 - 55 Gallon Elevator with Drum Lid only

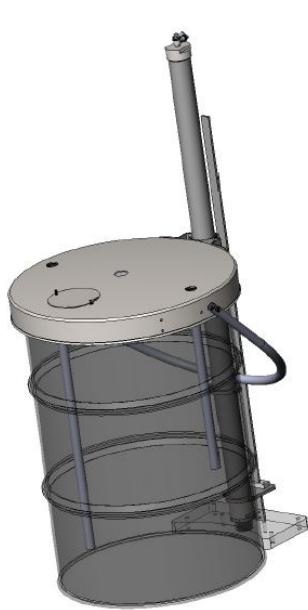

3099-5520-002 - 55 Gallon Elevator with Drum Lid only

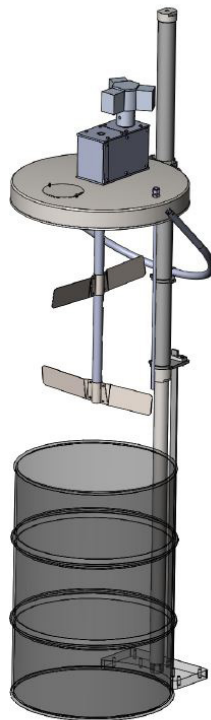

3092-BG55-000 - 55 Gallon Back Geared Agitator with Elevator and Drum Lid

\*Backgear available in 1:1, 2:1 and 3:1

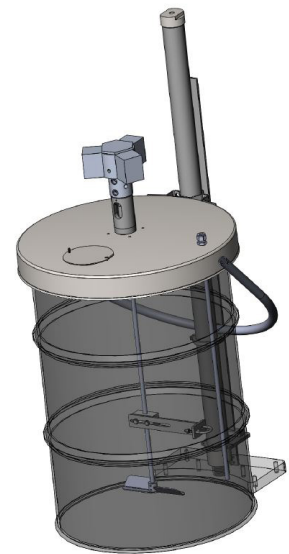

3099-5520-000 - 55 Gallon Direct Drive Agitator with Elevator and Drum Lid

## Simple and Flexible Fifty-five Gallon Drum Lift System

- Smooth, strong lifting cylinder
- Full drum width mixing blades
- Twin mixing blades to thoroughly mix finishing materials
- Center siphon option for material transfer
- Stainless drum cover
- Versatile pump mounting system
- Mast lock maintains lid orientation

## Standard Features:

- Simple clean mechanical design
- Air flow control for agitator speed
- Ultra-low air consumption
- Elevator lift reduces ergonomic issues
- Large center feed blending blade and slow speed reduces process issues

## Technical Specifications:

Maximum Air Inlet Pressure: 105 psi

Air Inlet Connection: 1/4" NPT (f)

Maximum Weight Capacity: 250 lbs. @60 psi, 400 lbs. @100 psi

Currently we supply with the standard air quick disconnect so that the unit is not raised unless the rotation has been deactivated.

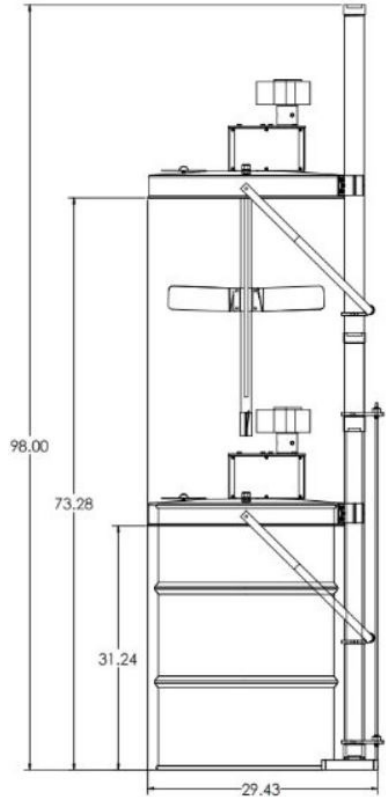

Width of unit approximately 27.5

## Options:

- 3076-00-00A Optional Speed Control Regulator
- 3077-AM20-000 Optional Air Motor

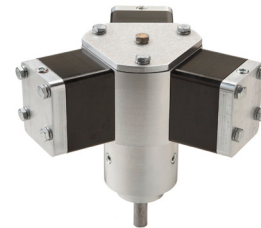

## Air Flow Control Technical Specifications:

3076-30-00 Standard 3/8" Inlet/Outlet Port

3076-40-00 Optional 1/2" Inlet/Outlet Port

## Air Motor Technical Specifications:

Environmental / Physical

Temperature Range: 14°F to 176°F

Height: 8.25"

Diameter: 8.0"

Weight: 8.4 lbs<sup>o</sup>

Note: Pumps sold separately.

\*Please contact your AQ sales representative at 262-781-6133 for more info.

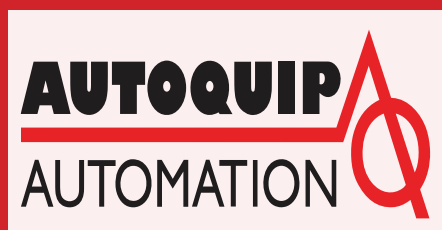

[www.aqautomation.com](http://www.aqautomation.com)

N57W13430 Reichert Avenue  
Menomonee Falls, WI 53051  
Tel. 262-781-6133 Fax 262-781-6188  
[sales@aqautomation.com](mailto:sales@aqautomation.com)