

# ECO-Flow Controller

#3076-AFC3-000\*

#3076-AFC4-000\*

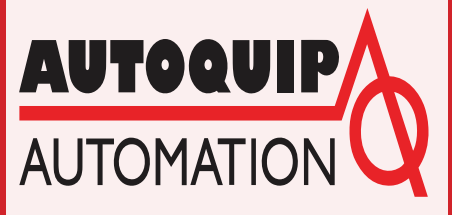

*Need a Solution to Air Flow Control Problems?  
Autoquip has the Solution!*

## System Description

The AQ ECO-Flow Controller is a patented device that controls both air pressure and flow to mechanisms like pneumatically driven motors and cylinders. The device is designed to eliminate problems associated with transferring energy, utilizing pressurized air, and pressure controlled regulators.

The AQ ECO-Flow Controller incorporates a dual mode combination of a pressure regulator, flow regulator, and pneumatic flow switch to accomplish the control. During a stopped or stalled condition the ECO-Flow Controller output pressure is automatically set to an adjustable level. When a change in energy is required, an air flow change is sensed, switching the control of the unit from pressure to flow modulation. During modulation mode the output pressure of the AQ ECO-Flow Controller is adjusted to maintain a specific flow rate and torque.

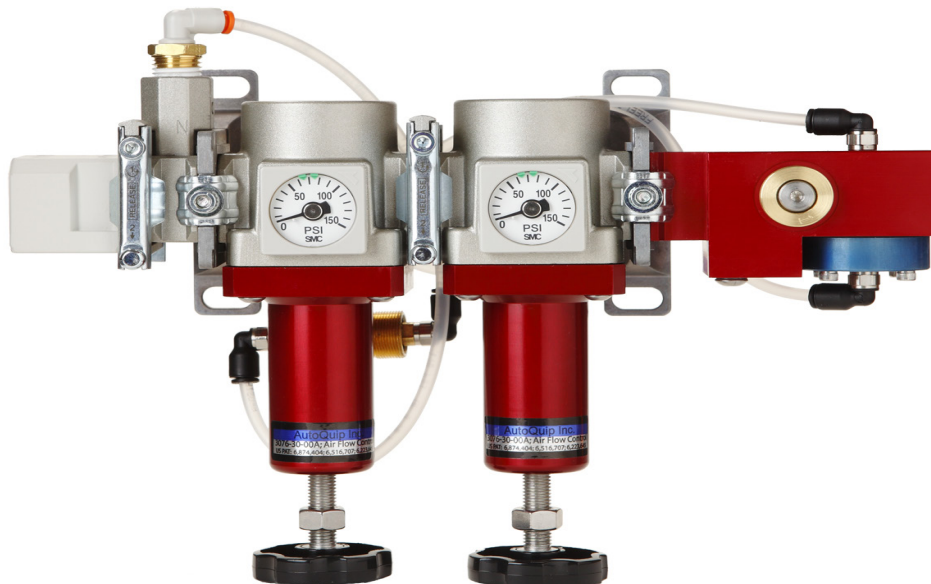

*Maintains agitator speed 6 times better than standard regulated air*

## Applications:

- Paint agitator motor speed control
- Paint pump cycle limit control
- Paint spray gun atomization rate control
- Air sander speed control
- Air tool speed and torque control
- Air cylinder rate and pressure control

## Standard Features:

- Systematically controls both air pressure and flow rate.
- Controls static delivery pressure and flow rate dynamically.
- Independent adjustment of static pressure and dynamic flow.
- Reduces pneumatic problems caused by pressure drop hoses.
- Regulates agitator speed and torque control.

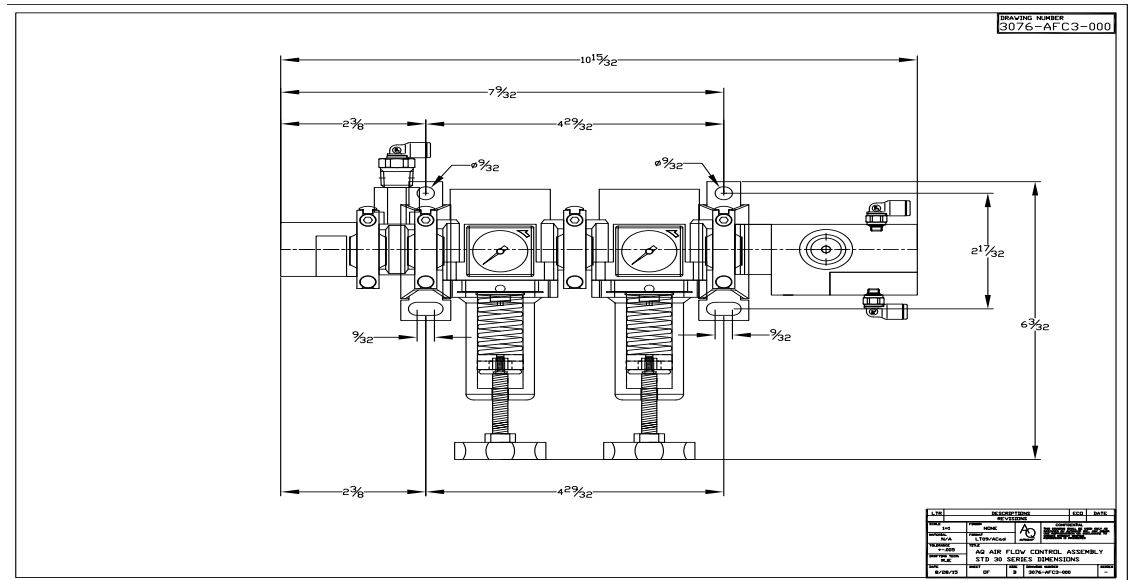

## Ordering Info

### ECO-Flow Controller

3076-AFC3-000 Standard 3/8" Inlet/Outlet Port

3076-AFC4-000 Optional 1/2" Inlet/Outlet Port

### Controlling Orifice - One Required Per Unit

Standard Orifice #1 - 2.2ft<sup>3</sup>/min

Other Orifice sizes are available for special applications

### Spare Parts

3076-AFCR-000 - Rebuild Kit

### Optional

3076-40-01A Supply Control Valve

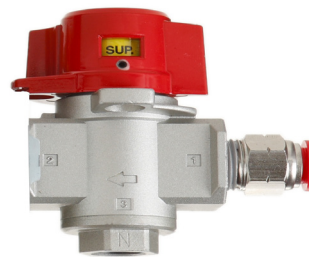

Supply Control Valve

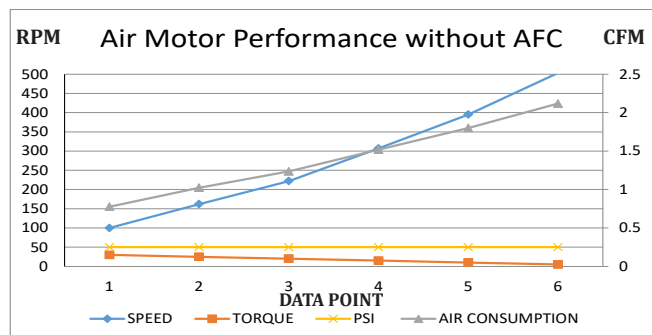
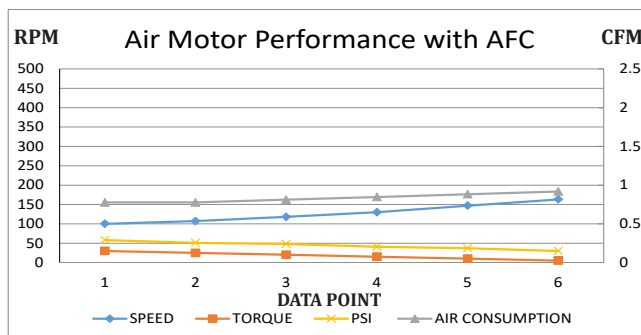

Autoquip tests were performed with a Model DSP7000 High Speed Programmable Dynamometer Controller. The tests are simulating what an agitator motor does as a large tank or 55 gallon barrel of paint does as materials are used and the vessel level changes from full to empty. Observations include: RPM's of air motor remains much more consistent with original speed settings, less usage of air as material is used.

\*Replaces part #3076-00-00A

Patent No.: US 6,223,645 BI Date of Patent: May 1, 2001

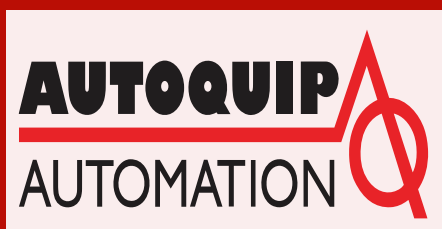

[www.aqautomation.com](http://www.aqautomation.com)

N57W13430 Reichert Avenue  
Menomonee Falls, WI 53051  
Tel. 262-781-6133 Fax 262-781-6188  
sales@aqautomation.com